

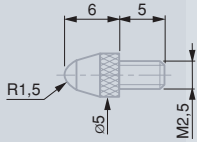

Measuring Inserts for Dial Gauges, Axial Probes and other Hand-Held Tools

Executions with a M2,5 coupling thread



Standard spherical measuring inserts.

No		L mm
03510001	Steel	6
03510002	Carbide	6
03560001	Sapphire	6

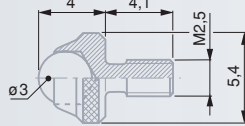

Short spherical measuring insert.

No		L mm
03560007	Carbide	4

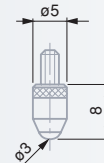

Long spherical measuring inserts.

No		L mm
03560019	Steel	8
03560020	Carbide	8
03560021	Sapphire	8

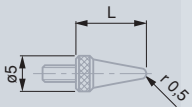

Spherical measuring inserts,
R = 0,5 mm.

No		L mm
03560035	Steel	5
03560036	Steel	10
03560037	Steel	15
03560038	Steel	20
03560039	Steel	30
03560040	Steel	40

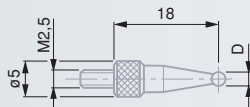

Spherical measuring inserts.

No		mm
03560051	Carbide	1
03560052	Carbide	2
03560053	Carbide	3
03560054	Carbide	4
03560055	Carbide	5
03560056	Carbide	6
03560057	Carbide	7
03560058	Carbide	8
03560059	Carbide	9
03560060	Steel	10
03560061	Steel	11
03560062	Steel	12

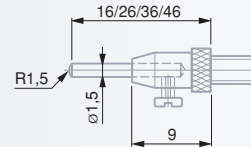

Spherical measuring insert with
4 interchangeable pins, R = 1,5 mm.

No		L mm
03510201	Steel	16, 26, 36, 46

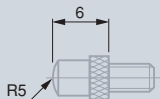

Spherical measuring inserts.

No		R mm
03510101	Steel	5
03510102	Carbide	5

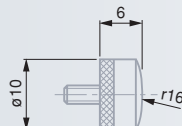

Spherical measuring inserts

No		R mm
03560017	Steel	16
03560018	Carbide	16

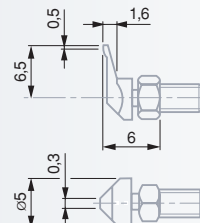

Measuring insert with offset (A)
contact point and lock nut for radial
alignment.

No		A mm
03510401	Steel	6,5



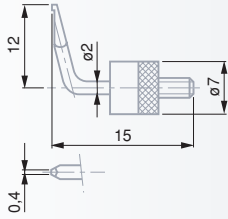

Measuring insert with offset (A) contact point and lock nut for radial alignment.

03560063	Steel	12

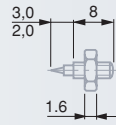

Insert with needle contact point.

03560030	Steel

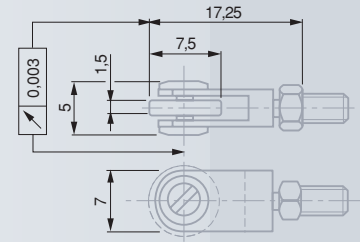

Measuring inserts with ball-bearing rollers. Lock nut for radial alignment.

03560010	Steel	cylindrical
03560011	Steel	ball-shaped

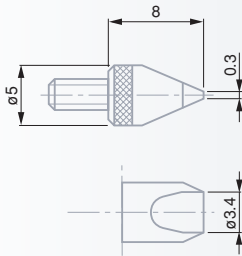

Measuring inserts with blade-shaped measuring face. Lock nut for radial alignment

03560024	Steel	0,3
03560025	Carbide	0,3

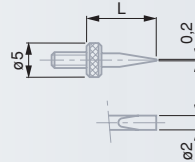

Measuring inserts with blade-shaped measuring face, in steel. Lock nut for radial alignment.

03560031		5	0,2
03560032		10	0,2
03560033		15	0,2
03560034		20	0,2

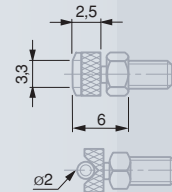

Insert with a cylindrical measuring face. Lock nut for radial alignment.

03510502	Carbide

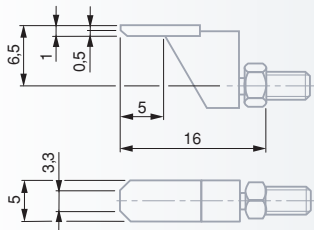

Insert with narrow, off-centre measuring face. Lock nut for radial alignment.

03510602	Carbide	0,5

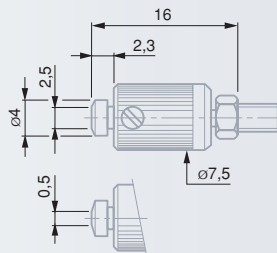

Insert with a narrow, parallel adjustable measuring face. Lock nut for radial alignment.

03510702	Carbide	0,5

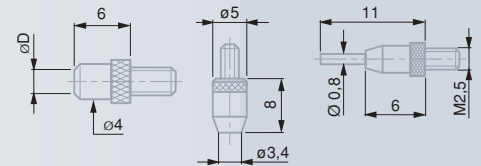

Inserts with a flat measuring face.

03510801	Steel	2,5
03510802	Carbide	2,5
03560022	Steel	3,4
03560023	Carbide	3,4
03560081	Carbide	0,8

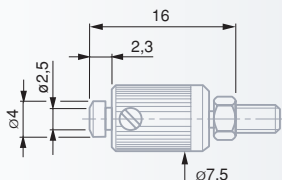

Measuring insert with a flat, parallel adjustable measuring face. Lock nut for radial alignment.

03510902	Carbide	2,5

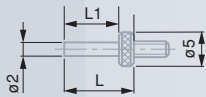

Steel inserts with a flat measuring face.

N ^o	L mm	L1 mm	mm
03560026	5	2,8	2
03560027	10	7,8	2
03560028	15	12,8	2
03560029	20	17,8	2

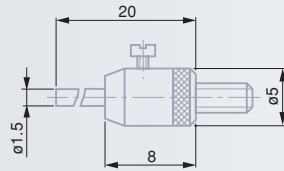

Inserts with a flat measuring face as well as interchangeable pin.

N ^o	Material	Length mm
03560008	Steel	1,5
03560009	Carbide	1,5

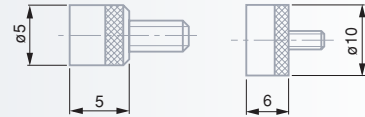

Inserts with a flat measuring face.

N ^o	Material	Length mm
03560012	Steel	5
03560013	Carbide	5
03560014	Steel	10
03560015	Carbide	10
03560016	Steel	20

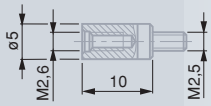
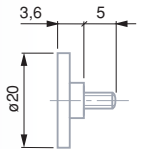

Connectors for measuring inserts.

N ^o	Inside	Outside
03560066	M2,5	M2,6
03560067	M2,5	M3
03560064	M2,6	M2,5
03560065	M3	M2,5
03560068	M2,5	6BA
03560069	M2,5	8BA
03560070	6BA	M2,5
03560071	8BA	M2,5

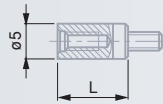

Extensions for measuring inserts.

N ^o	L mm
03560042	10
03560043	15
03560044	20
03560045	25
03560046	30
03560047	35
03560048	40
03560049	45
03560050	50

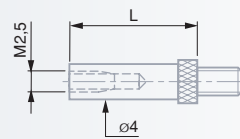

Extensions for measuring inserts.

N ^o	L mm
03540501	10
03540502	15
03540503	20
03540504	40

Executions with a M2 Coupling Thread

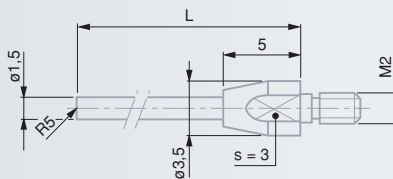
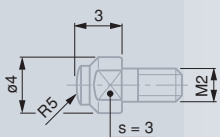
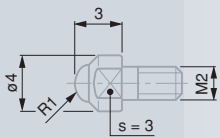

Spherical measuring inserts, R = 5 mm. M2 thread.

N ^o	Material	L mm
03510202	Carbide	16
03510203	Carbide	26

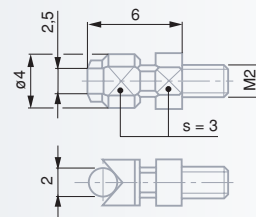

Measuring insert with cylindrical measuring face. Lock nut for radial alignment. M2 thread.

N ^o	Material
03510503	Carbide

Spherical measuring inserts. M2 thread.

N ^o	Material	R mm
03510204	Carbide	R 1
03510103	Carbide	R 5

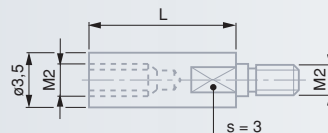

Extensions for measuring inserts, M2.

N ^o	L mm
03540505	10
03540506	15

Devices for Plunger Retraction



Top mounted retraction devices.

N ^o	Diagram	mm
03560004		Ø 40
03560005		Ø 58

Each consisting of:

- Lift lever
- Head screw



Bottom mounted retraction device.

N ^o	Diagram	
03540104		Retraction device

Consisting of:

03540101	Lift lever
03540102	Washer



Bottom mounted lift lever.

N ^o	
01960005	



90° Angle Probe



N ^o	Diagram	
03560006		90° angle probe used for the transmission of the plunger movement up to 10 mm. Suited for dial gauges with a 0,01 mm scale division.

Furnished with:

03560012	Measuring insert with a 5 mm diameter flat face
----------	---





A Dull-chrome plated, except for models No. 01460010, 01460011, 01460016 and 01460017

H Holding force = 150 N

Backs for TESA YR, TESA YE, MERCER and COMPAC Dial Gauges

Executions for dial gauges with a 40 mm dial diameter



01460008	A	Back with central lug
01460009	B	Back with offset lug
01460010	C	Back with a 8 mm dia. fixing shank
01460011	D	Back with M6 inner thread
01460012	E	Back with permanent magnet

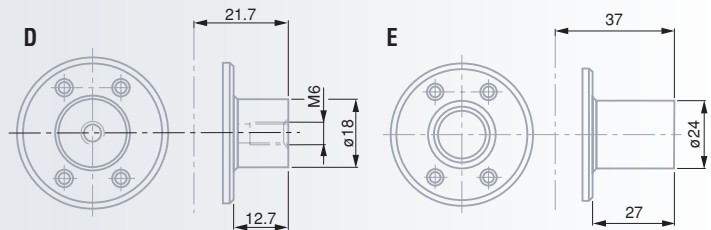
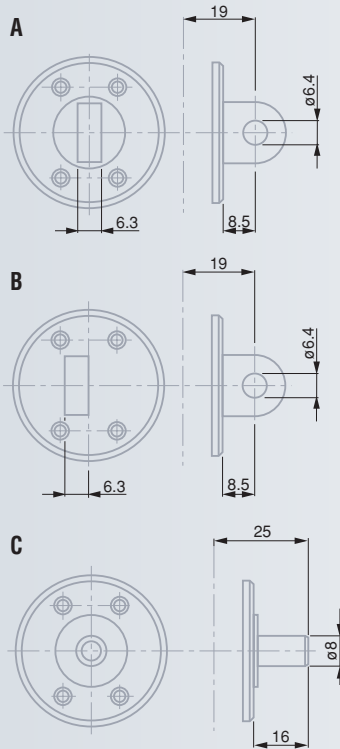

Executions for dial gauges with a 58 or 82 mm dial diameter



01460013	A	Flat back
01460014	B	Flat back with central lug
01460015	C	Flat back with offset lug
01460016	D	Back with a 8 mm dia. fixing shank
01460017	E	Back with a M6 inner thread
01460018	F	Back with 4 clamping bores as per CNOMO French standard
01460019	G	Back with permanent magnet

